



R. A. Anderson
wood products, inc.

PRODUCT
CATALOG



R. A. Anderson
wood products, inc.

Table of Contents

RECEPTION STATIONS	1-1 to 1-4
CONFERENCE TABLES	2-1 to 2-4
CUSTOMIZED WORKSTATIONS	3-1 to 3-7
QUICK SHIP	4-1
DESKS & CREDENZAS	5-1 to 5-4
LABS & STORAGE ROOMS	6-1 to 6-3

'R' STYLE RECEPTION DESK

RECEPTION STATIONS

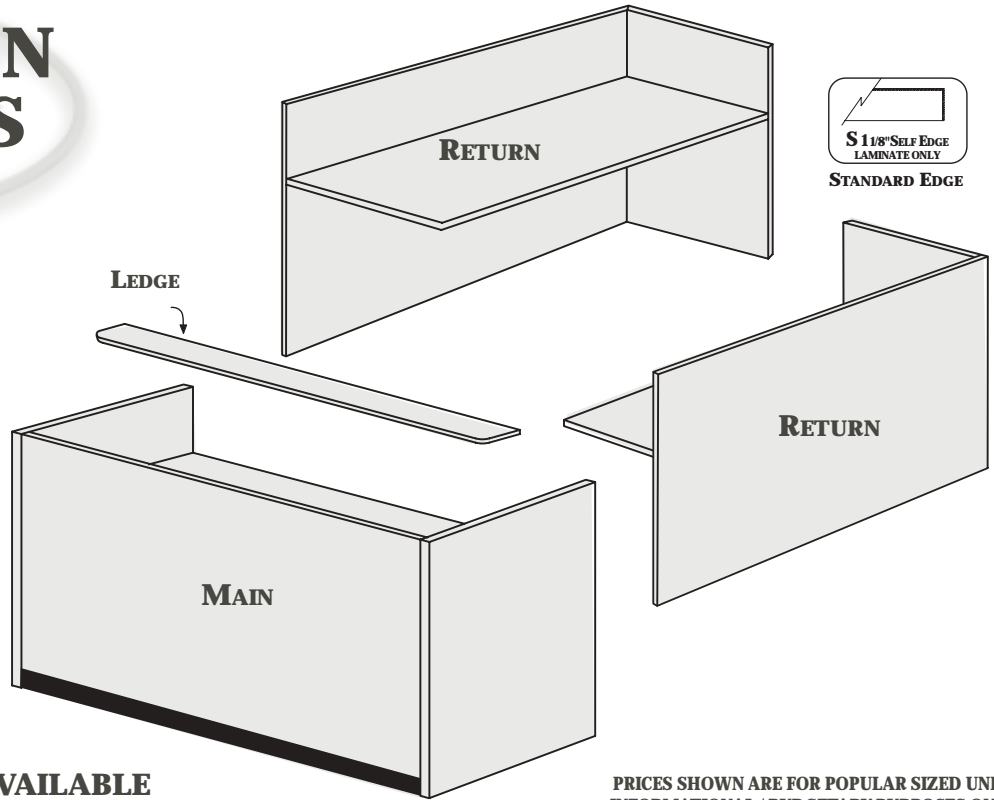
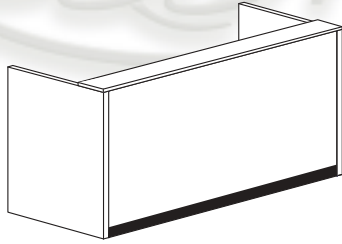

Quotes are given in Standard HPL which includes solids and regular woodgrains in a matte finish with melamine interiors...

Melamine selection:

White Black Grey Almond

UNLIMITED VARIATIONS AVAILABLE

PRICES SHOWN ARE FOR POPULAR SIZED UNITS
INFORMATIONAL / BUDGETARY PURPOSES ONLY.

FOR EXACT PRICING FAX OR CALL WITH COMPLETE SPECIFICATIONS

MAIN STATION

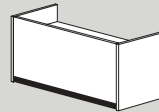
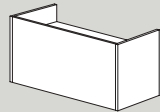

Size	Flush to Floor	Recessed Toe	12" Ledge/Transtop
24x60	\$1,325	\$1,425	\$135
30x60	1,380	1,485	135
24x66	1,465	1,575	160
30x66	1,550	1,660	160
24x72	1,600	1,720	185
30x72	1,660	1,790	185
24x84	1,695	1,834	200
30x84	1,785	1,920	200
24x96	1,785	1,940	220
30x96	1,870	2,020	220

PRICES INCLUDE USING A STANDARD SELF EDGE (CALL FOR PRICING ON OTHER EDGES)

RETURNS*

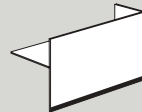
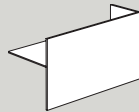

Size	Flush to Floor	Recessed Toe	12" Ledge/Transtop
24x42	\$1,120	\$1,210	\$115
30x42	1,145	1,230	115
24x48	1,145	1,245	125
30x48	1,180	1,275	125
24x60	1,180	1,285	130
30x60	1,235	1,340	130
24x72	1,235	1,365	185
30x72	1,370	1,490	185

PRICES INCLUDE USING A STANDARD SELF EDGE (CALL FOR PRICING ON OTHER EDGES)

*SPECIFY RIGHT, LEFT OR BOTH

OPTIONS

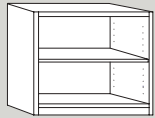
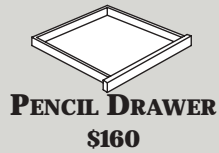

**PRINTER CABINET
24"W 30"W
\$561 \$633**

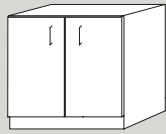

**PRINTER CABINET
24"W 30"W
\$676 \$751**

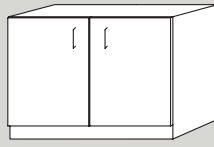

**DOOR STORAGE CABINET
24"W 30"W 36"W
\$546 \$604 \$676**

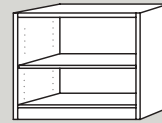

**OPEN SHELF STORAGE
24"W 30"W 36"W
\$431 \$489 \$518**

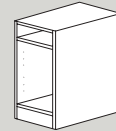

**CPU CABINET
12"W
\$274**



**FREESTANDING DRAWER PEDESTALS
\$550**

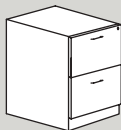

\$550

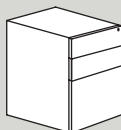

**MOUNTED DRAWER PEDESTALS
\$498**

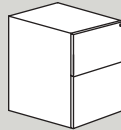

\$498

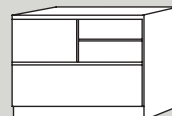

**COMBO FILE
32"W
\$900**

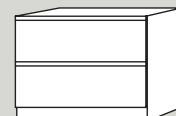

**LATERAL FILE
30"W 36"W
\$782 \$834**

AVAILABLE EDGE TREATMENTS

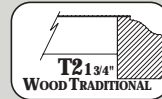
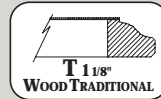
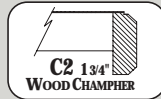
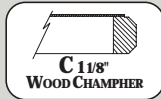
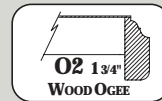
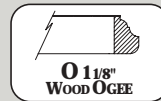
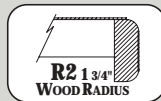
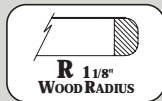
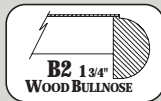
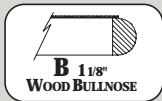
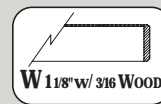
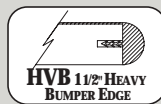
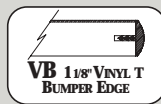
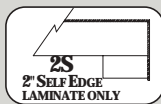
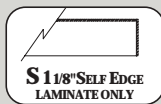

DESIGN INFORMATION

**INCLUDED:
WIRE ACCESS GROMMETS
SPECIFY LOCATION
(3" STANDARD)**

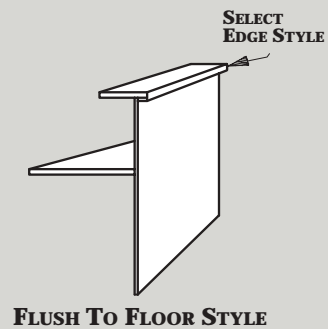
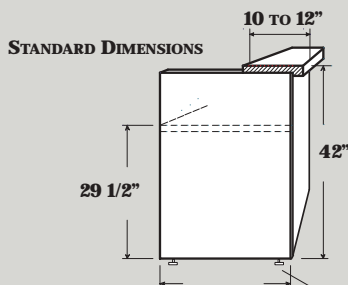
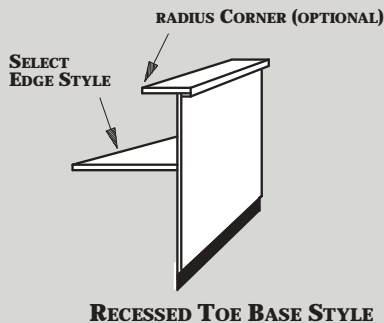

RECEPTION STATIONS

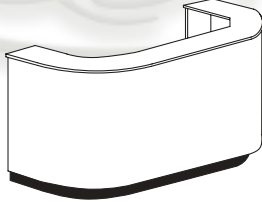

'C' STYLE RECEPTION DESK

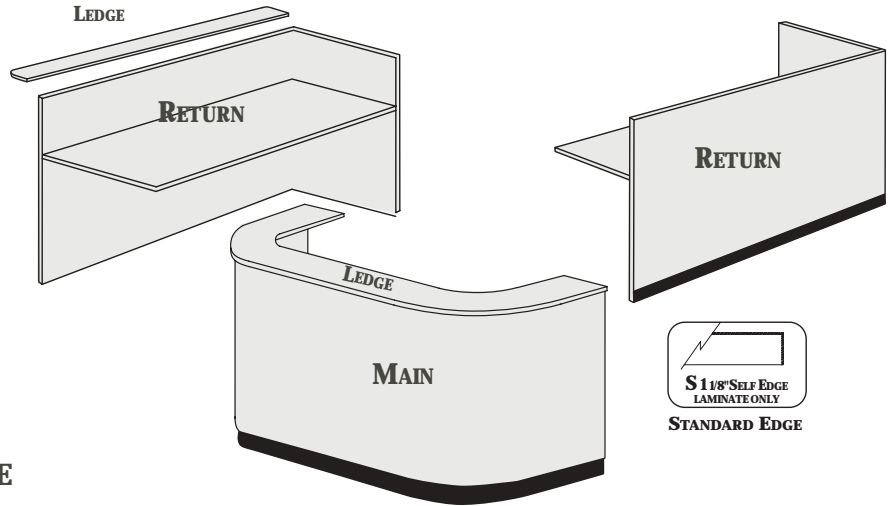

PRICES SHOWN ARE FOR POPULAR SIZED UNITS
INFORMATIONAL / BUDGETARY PURPOSES ONLY.

FOR EXACT PRICING FAX OR CALL WITH COMPLETE SPECIFICATIONS

UNLIMITED VARIATIONS AVAILABLE

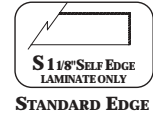

MAIN STATION

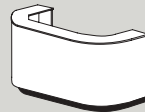
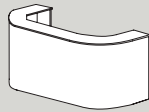

Size	Flush to Floor	Recessed Toe	12" Ledge
24x72	\$2,749	\$3,163	included
30x72	2,846	3,272	included
24x84	2,846	3,272	included
30x84	3,013	3,507	included
24x96	3,013	3,507	included
30x96	3,283	3,910	included

PRICES INCLUDE USING A STANDARD SELF EDGE (CALL FOR PRICING ON OTHER EDGES)

RETURNS*

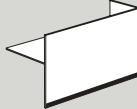
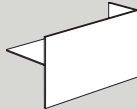

Size	Flush to Floor	Recessed Toe	12" Ledge
24x42	\$1,120	\$1,210	\$115
30x42	1,145	1,230	115
24x48	1,145	1,240	125
30x48	1,180	1,275	125
24x60	1,180	1,285	130
30x60	1,235	1,340	130
24x72	1,235	1,365	185
30x72	1,370	1,490	185

PRICES INCLUDE USING A STANDARD SELF EDGE (CALL FOR PRICING ON OTHER EDGES)

*SPECIFY RIGHT, LEFT OR BOTH

WALL END ROUNDED RADIUS CORNER



Size	Flush to Floor	Recessed Toe	12" Ledge
24x72	\$2,317	\$2,490	included
30x72	2,415	2,588	included
24x84	2,415	2,588	included
30x84	2,581	2,760	included
24x96	2,581	2,760	included
30x96	2,852	3,025	included

PRICES INCLUDE USING A STANDARD SELF EDGE (CALL FOR PRICING ON OTHER EDGES)

*SPECIFY RIGHT, LEFT OR BOTH

OPTIONS

ANGLED KEYBOARD CORNER
(WHERE AVAILABLE)
\$520

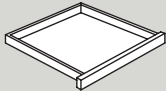

PENCIL DRAWER
\$160

KEYBOARD
\$160

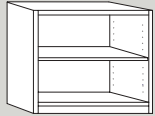

ARTICULATING KEYBOARD
\$345

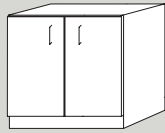

PRINTER CABINET
24"W 30"W
\$561 \$633

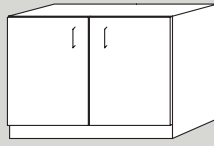

PRINTER CABINET
24"W 30"W
\$676 \$751



DOOR STORAGE CABINET
24"W 30"W 36"W
\$546 \$604 \$676

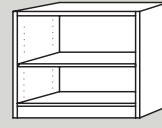

OPEN SHELF STORAGE
24"W 30"W 36"W
\$431 \$489 \$518

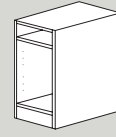

CPU CABINET
12"W
\$274



FREESTANDING DRAWER PEDESTALS
\$550

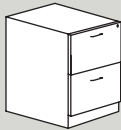

FREESTANDING DRAWER PEDESTALS
\$550

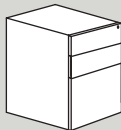

MOUNTED DRAWER PEDESTALS
\$498

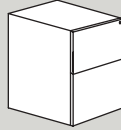

MOUNTED DRAWER PEDESTALS
\$498

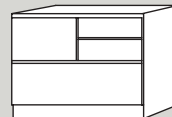

COMBO FILE
32"W
\$900

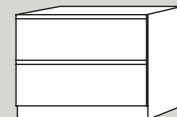

LATERAL FILE
30"W 36"W
\$782 \$834

AVAILABLE EDGE TREATMENTS

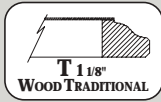
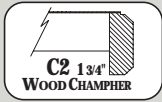
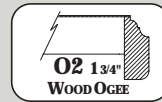
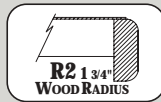
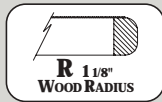
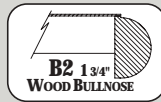
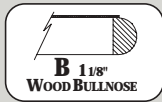
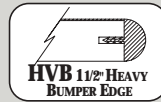
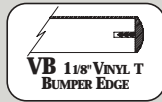
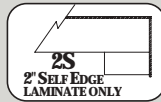
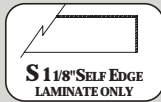

DESIGN INFORMATION

INCLUDED:
 **WIRE ACCESS GROMMETS**
SPECIFY LOCATION
(3" STANDARD)

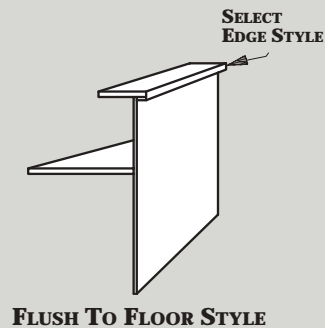
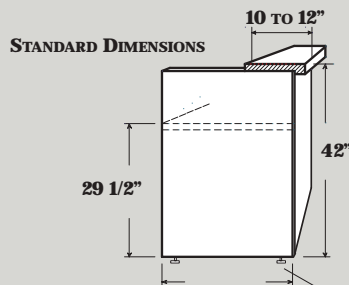
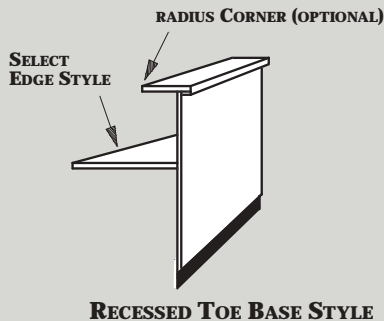

CONFERENCE TABLES

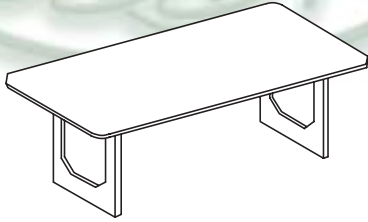

DESIGN YOUR OWN CONFERENCE TABLE THE RAA WAY...

1. SELECT BASE STYLE
2. SELECT EDGE STYLE
3. SELECT TOP STYLE

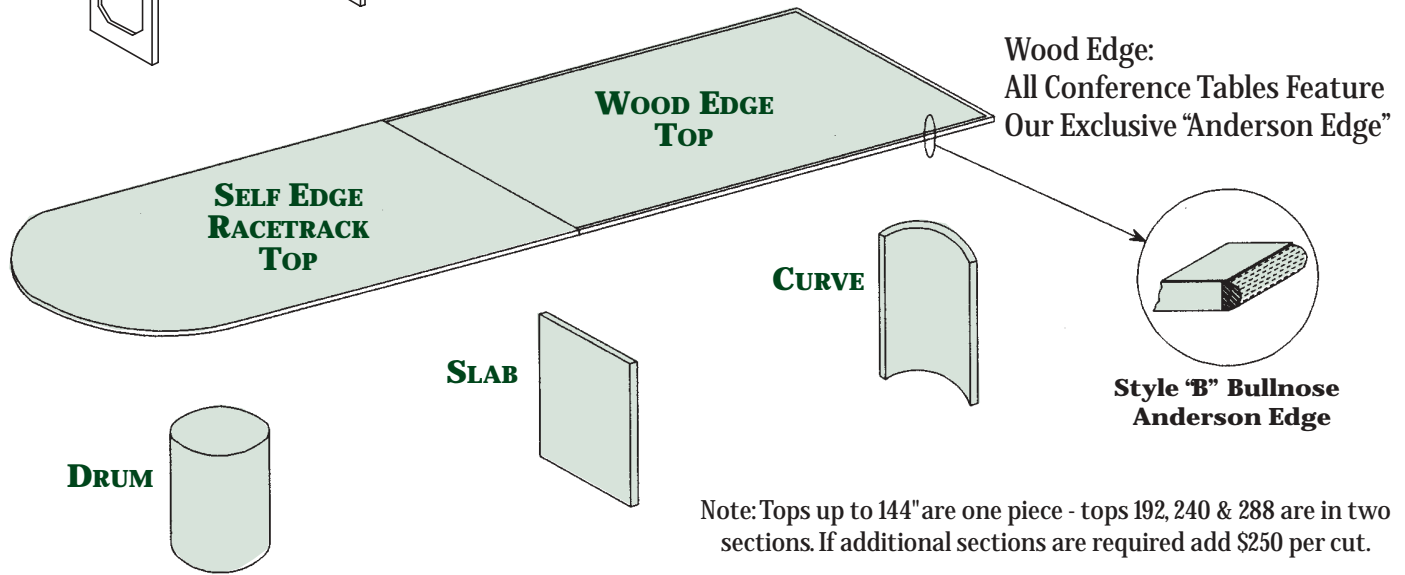

BASE OPTIONS

Slab leg	Slab leg with Toe	Curve	Curve with Toe	Drum	Drum with Toe	1/2 Drum	1/2 Drum with Toe	Traditional Slab	Traditional Slab w/Toe
\$186	\$217	\$273	\$288	\$550	\$646	\$550	\$646	\$275	\$302
Traditional Cube	Traditional Cube With Toe	Laminate X Base	Pole Leg 3"	Chrome or Black X Base	Chrome or Black T Leg	Chrome Folding	Duncan Phyfe	Queen Anne	
\$604	\$690	\$374	\$85	\$260	\$359	\$359 pr.	\$535 pr.	\$564 ea.	\$564 ea.

Note: All leg/base styles may not be appropriate for all table styles.

AVAILABLE EDGE TREATMENTS

S 1 1/8" SELF EDGE LAMINATE ONLY	2S 2" SELF EDGE LAMINATE ONLY	VB 1 1/8" VINYL T BUMPER EDGE	HVB 1 1/2" HEAVY BUMPER EDGE	C 1 1/8" WOOD CHAMFER	B 1 1/8" WOOD BULLNOSE	R 1 1/8" WOOD RADIUS
O 1 1/8" WOOD OGEE	C2 1 3/4" WOOD CHAMFER	B2 1 3/4" WOOD BULLNOSE	R2 1 3/4" WOOD RADIUS	O2 1 3/4" WOOD OGEE	T 1 1/8" WOOD TRADITIONAL	T2 1 3/4" WOOD TRADITIONAL

CONFERENCE TOPS

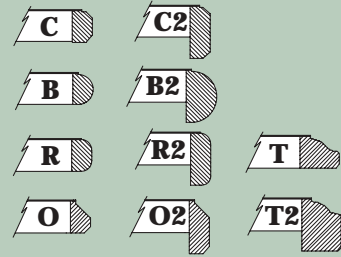

RECTANGLE

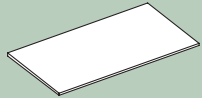

	Size	Bases Required	Price	Price	Price	Price	Price	Price	Price
1 pc	36 x 72	2	\$434	\$476			\$1,158	\$1,268	\$1,337
1 pc	42 x 84	2	527	578			1,372	1,491	1,581
1 pc	48 x 96	2	589	649			1,555	1,693	1,794
1 pc	48 x 120	2	661	727			1,788	1,949	2,067
1 pc	48 x 144	2	811	891			2,099	2,283	2,420
2 pc	48 x 192	3	1,049	1,153			2,659	2,889	3,061
1 pc	60 x 120	2	863	949			2,070	2,243	2,377
1 pc	60 x 144	2	1,012	1,113			2,381	2,576	2,730
2 pc	60 x 192	3	1,147	1,381			2,946	3,188	3,379
2 pc	60 x 240	4	1,507	1,656			3,519	3,807	4,034
2 pc	60 x 288	4	2,197	2,403			4,531	4,865	5,155

BOAT



1 pc	36 x 72	2	\$572	\$614	\$758	\$799	\$1,296	\$1,518	\$1,609
1 pc	42 x 84	2	665	716	882	930	1,510	1,725	1,829
1 pc	48 x 96	2	727	787	975	1,030	1,693	1,923	2,038
1 pc	48 x 120	2	799	865	1,089	1,144	1,926	2,151	2,279
1 pc	48 x 144	2	995	1,075	1,326	1,436	2,283	2,507	2,657
2 pc	48 x 192	3	1,233	1,337	1,647	1,785	2,843	3,069	3,253
1 pc	60 x 120	2	1,000	1,104	1,311	1,369	2,208	2,430	2,575
1 pc	60 x 144	2	1,196	1,297	1,541	1,646	2,570	2,805	2,974
2 pc	60 x 192	3	1,440	1,565	1,875	2,019	3,130	3,285	3,559
2 pc	60 x 240	4	1,690	1,840	2,208	2,380	3,703	3,979	4,217
2 pc	60 x 288	4	2,381	2,611	2,981	3,173	4,715	4,980	5,277

RACETRACK



1 pc	36 x 72	2	\$520	\$558	\$720	\$758	\$1,262	\$1,472	\$1,586
1 pc	42 x 84	2	604	651	837	882	1,472	1,696	1,806
1 pc	48 x 96	2	661	715	926	987	1,613	1,854	2,015
1 pc	48 x 120	2	727	787	1,033	1,089	1,908	2,082	2,254
1 pc	48 x 144	2	905	978	1,259	1,357	2,220	2,444	2,632
2 pc	48 x 192	3	1,121	1,217	1,564	1,658	2,772	2,992	3,209
1 pc	60 x 120	2	910	1,004	1,245	1,323	2,174	2,404	2,524
1 pc	60 x 144	2	1,088	1,180	1,464	1,552	2,529	2,757	2,951
2 pc	60 x 192	3	1,310	1,424	1,780	1,888	3,094	3,300	3,541
2 pc	60 x 240	4	1,538	1,674	2,098	2,216	3,669	3,920	4,171
2 pc	60 x 288	4	2,165	2,375	2,831	2,989	4,702	4,934	5,231

RADIUS CORNER RECTANGLE

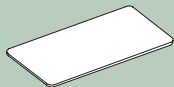

1 pc	36 x 36	1	\$175	\$230	N/A	N/A	\$457	\$483	\$528
1 pc	42 x 42	1	206	263	N/A	N/A	530	561	598
1 pc	48 x 48	1	222	279	N/A	N/A	624	656	694
1 pc	54 x 54	1	309	367	N/A	N/A	1,000	1,050	1,080
1 pc	60 x 60	1	336	278	N/A	N/A	1,015	1,066	1,107

RADIUS CORNER SQUARE



1 pc	36 x 36	1	\$221	\$286	\$328	\$380	\$572	\$621	\$644
1 pc	42 x 42	1	252	321	368	437	644	693	723
1 pc	48 x 48	1	265	333	389	457	736	794	820
1 pc	54 x 54	1	344	391	437	506	1,104	1,219	1,252
1 pc	60 x 60	1	382	428	454	523	1,130	1,254	1,379

ROUND



1 pc	36 Diameter	1	\$255	\$309	\$339	\$390	\$802	\$859	\$882
1 pc	42 Diameter	1	286	344	378	431	897	955	1,014
1 pc	48 Diameter	1	302	391	430	493	976	1,034	1,057
1 pc	54 Diameter	1	386	445	488	557	1,334	1,403	1,436
1 pc	60 Diameter	1	424	485	534	607	1,372	1,609	1,643

DOOR CREDENZAS

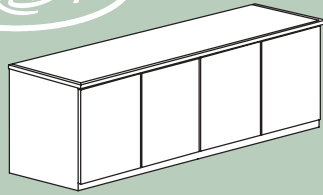

DOOR CREDENZA STORAGE



SIZE	PRICE	PRICE	PRICE
20 x 60	\$1,384	\$1,956	\$1,889
20 x 66	1,390	1,964	1,910
20 x 72	1,426	2,019	1,947
24 x 60	1,423	2,014	1,942
24 x 66	1,445	2,044	1,972
24 x 72	1,502	2,122	2,086

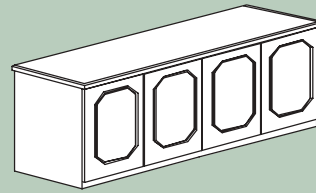

TRADITIONAL STYLE DOOR CREDENZA



SIZE	PRICE	PRICE	PRICE
20 x 60	\$1,987	\$2,784	\$2,713
20 x 66	2,003	2,806	2,735
20 x 72	2,031	2,843	2,772
24 x 60	2,026	2,837	2,766
24 x 66	2,049	2,869	2,797
24 x 72	2,106	2,946	2,874

SIDE TABLES

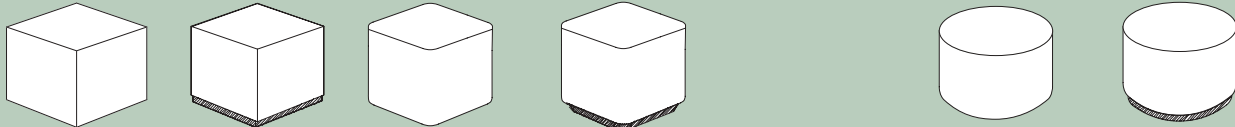

	Cube	Cube Recessed Base	Radius Corner Cube	Radius Corner Cube Recessed Base	Drum	Drum With Toe
18 x 18 x H	\$304	\$442	\$578	\$694	16 DIA x H \$557	\$672
18 x 24 x H	332	470	598	713	18 DIA x H 553	680
20 x 20 x H	357	493	597	712	20 DIA x H 587	702
24 x 24 x H	388	525	645	760	24 DIA x H 614	729
24 x 30 x H	435	473	658	773	30 DIA x H 643	758
30 x 30 x H	460	621	658	773	36 DIA x H 754	869
36 x 36 x H	578	728	755	871		

(Height may be up to 24 inches, call for custom.)

PANEL END TABLE

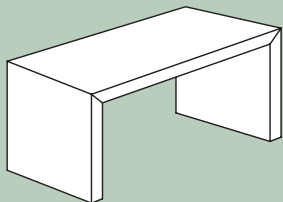

PARSONS TABLE

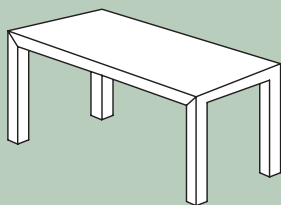

	Panel End Table	Parsons Table
15 x 48 x H	\$417	N/A
15 x 60 x H	454	N/A
15 x 72 x H	535	N/A
18 x 60 x H	512	\$535
18 x 72 x H	592	615
24 x 24 x H	401	424
24 x 36 x H	448	483
24 x 48 x H	621	650
24 x 60 x H	684	713
24 x 72 x H	988	1,035
30 x 30 x H	544	574
30 x 48 x H	610	635
30 x 60 x H	988	1,014
30 x 72 x H	1,051	1,107

(Height may be up to 29-1/2 inches, call for custom.)

TELEPHONE TABLE

WITH SHELF WITH DRAWER

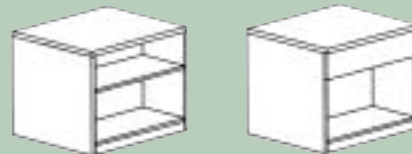

	Shelf	Drawer
18 x 18 x H	\$529	\$667
24 x 18 x H	552	684

(Height may be up to 24 inches, call for custom.)

AUDIO/VISUAL CONSOLES

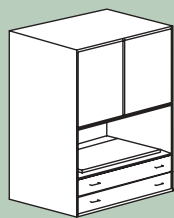

2 Door Console 30 x 24 x 60

	w/Casters
\$2,215	\$2,344

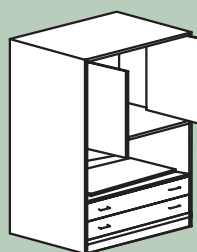

TV Monitor in top section behind 'Pocket Doors'
Pull out Mid Shelf for VCR,
2 Full Extension Storage Drawers
Cable access in back and thru shelves

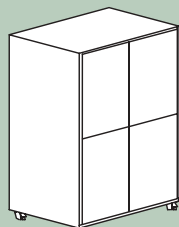
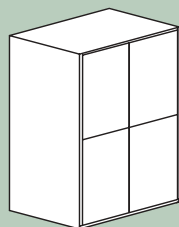

4 Door Console 30 x 24 x 60

	w/Casters
\$1,917	\$2,046

TV Monitor in top section behind 'Pocket Doors'
Behind Bottom Hinge Doors:
• Shelf for VCR
• 2 Storage Shelves
Cable access in back and thru shelves

LECTERNS

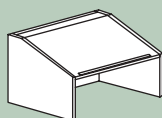
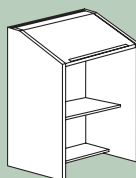
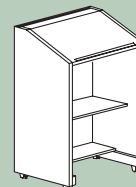

Table Top Use on top of desk or table	
Size	Price
23 x 19 x 19	\$575



Floor Lectern 42" to Document Edge	
Size	Price
23 x 19 x 48	\$820



Floor Lectern With Casters	
Size	Price
23 x 19 x 48	\$845

PRESENTATION BOARDS

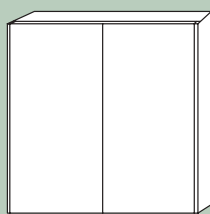

CONTEMPORARY

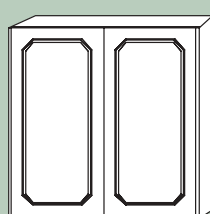

TRADITIONAL STYLE

Contemporary

Size	Price
48 x 48	\$1,704
60 x 48	1,942

Traditional Style

Size	Price
48 x 48	\$2,035
60 x 48	2,276

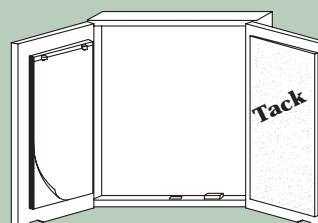

INCLUDES:

- Writing Surface
- Flip Chart
- Tackpanel
Guilford FR 701
#406 Silver Neutral

• Projection Screen (42'L x 41"W) Add: \$306

• Any Other FR701 Fabric on Tackpanel (Specify No.) Add: \$75

FRAMED WHITE BOARD



WALL HUNG WHITE BOARD
WITH PENCIL LEDGE

HEIGHT	36'L	48'L	60'L	72'L	96'L	120'L
36	\$590	\$655	\$725	\$799	\$937	\$1,086
48	655	725	799	886	1,070	1,258

CUSTOMIZED WORK STATIONS

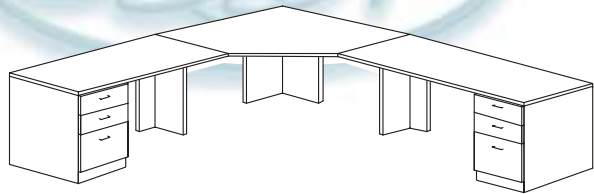

BEGIN BY:

- MEASURE AREA TO BE DESIGNED
- DECIDE WORK TOP LOCATION
- SUPPORT TOPS WITH:
 - A - SUPPORT LEGS
 - B - DRAWER STORAGE
 - C - DOOR STORAGE
- ADD PENCIL DRAWERS
- KEYBOARD DRAWERS
- HUTCH UNITS
- WALL CABINETS

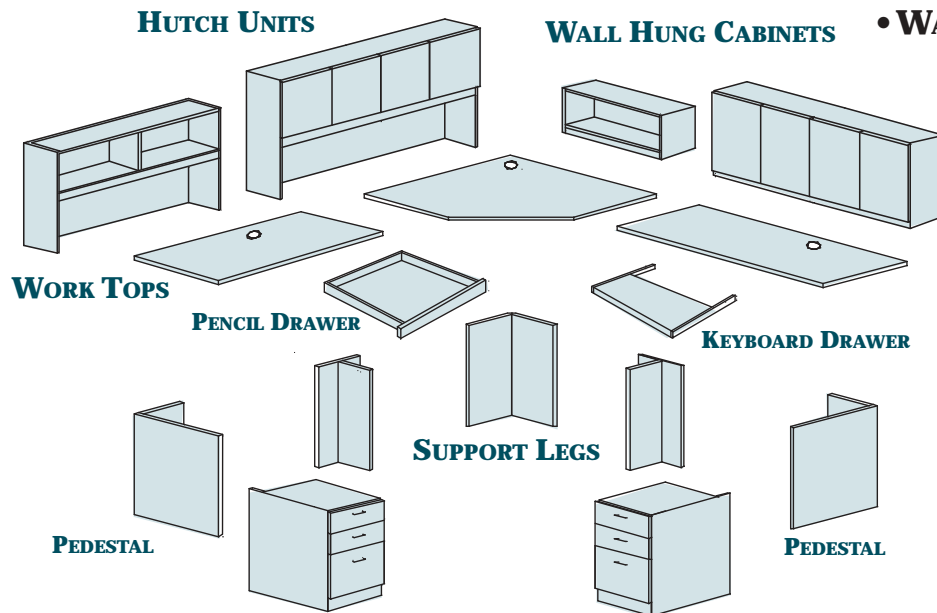





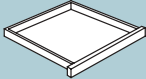
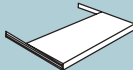

USE COMPONENT PARTS TO ATTAIN A 'CUSTOMIZED BUILT-IN' WORK AREA FOR MORE STORAGE—GO UP!!!

Quotes are given in Standard HPL which includes solids and regular woodgrains in a matte finish with melamine interiors...

Melamine selection:
 ___White ___Black ___Grey ___Almond

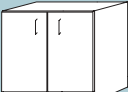
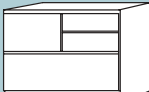
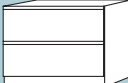
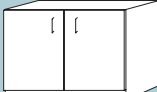
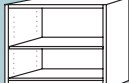
STORAGE OPTIONS

 PENCIL DRAWER \$160	 KEYBOARD \$160	 FREESTANDING DRAWER PEDESTALS \$550	 MOUNTED DRAWER PEDESTALS \$498	 PRINTER CABINET 24"W 30"W \$561 \$633
 PRINTER CABINET 24"W 30"W \$676 \$751	 COMBO FILE 32"W \$900	 LATERAL FILE 30"W 36"W \$782 \$834	 DOOR STORAGE CABINET 24"W 30"W 36"W \$546 \$604 \$676	 OPEN SHELF STORAGE 24"W 30"W 36"W \$431 \$489 \$518
				 CPU CABINET 12"W \$274

SUPPORT LEGS

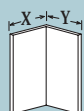

CORNER 'L' LEG

		3/4" MELAMINE LAMINATE	
X	Y	MELAMINE	LAMINATE
12	12	\$136	\$177
15	15	\$147	\$182
18	18	\$168	\$192

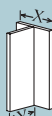

'L' LEG

		3/4" MELAMINE LAMINATE	
X	Y	MELAMINE	LAMINATE
12	8	\$136	\$182
12	12	\$136	\$182
12	14	\$147	\$190



'L' LEG
(SPECIFY RIGHT OR LEFT)

		3/4" MELAMINE LAMINATE	
X	Y	MELAMINE	LAMINATE
12	18	\$149	\$193
12	20	\$163	\$202
12	24	\$166	\$207
12	30	\$179	\$219

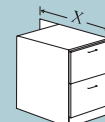

EXTENDED SIDE
FOR AN EXTENDED SIDE ON PEDESTAL OR CABINET PLEASE ADD THE FOLLOWING TO NORMAL PED/CAB PRICE

24D	30D	36D
\$53	\$67	\$94

WORK STATION TOPS

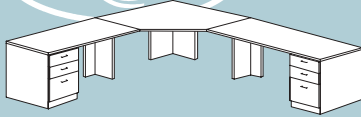

TYPE 'S' 1 1/8" THICK SELF EDGE

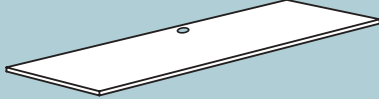

EXTRA WIRE GROMMETS \$22 EACH SPECIFY LOCATION

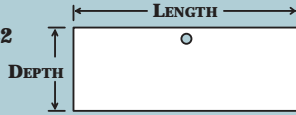

ALL TOPS INCLUDE ONE WIRE GROMMET - SPECIFY LOCATION

DEPTH

	20"	24"	30"	36"
30	\$156	\$177	\$189	\$219
36	182	190	265	232
42	214	228	242	248
48	231	231	244	258
54	288	294	311	345
60	301	310	317	305
66	329	333	380	403
72	366	373	403	446
84	414	407	437	453
96	421	414	454	467
108	518	559	610	650
120	529	603	605	669

LENGTH

CORNER TOPS

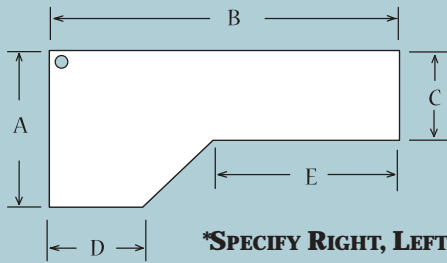
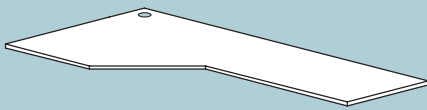

*SPECIFY RIGHT, LEFT OR BOTH



CORNER TOP TYPE 'S'*
1 1/8" THICK SELF EDGE

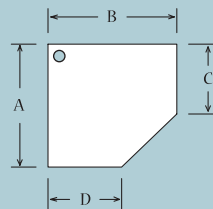

A	B	C	D	E	
48	78	30	30	30	\$729
48	84	30	30	36	\$752
48	90	30	30	42	\$757
48	96	30	30	48	\$787
48	72	30	24	30	\$729
48	78	30	24	36	\$752
48	84	30	24	42	\$757
48	90	30	24	48	\$787
48	66	30	20	30	\$729
48	72	30	20	36	\$752
48	78	30	20	42	\$757
48	84	30	20	48	\$787
42	78	24	30	30	\$718
42	84	24	30	36	\$734
42	90	24	30	42	\$768
42	96	24	30	48	\$782
42	72	24	24	30	\$651
42	78	24	24	36	\$667
42	84	24	24	42	\$702
42	90	24	24	48	\$715
42	66	24	20	30	\$651
42	72	24	20	36	\$667
42	78	24	20	42	\$702
42	84	24	20	48	\$715
48	48	30	30	—	\$541
48	42	30	24	—	\$541
48	38	30	20	—	\$541
42	48	24	30	—	\$541
42	42	24	24	—	\$475
42	38	24	20	—	\$475
38	48	20	30	—	\$540
38	42	20	24	—	\$475

NOVA KIT CUTOUT/INSTALLATION

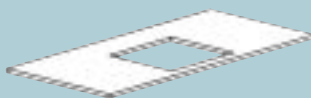

Cut out & Installation for nova kits available for an additional \$250ea

EDGE TREATMENTS

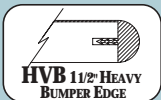
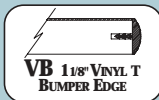
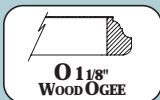
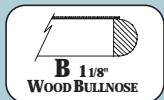
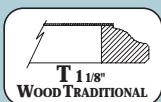
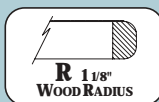
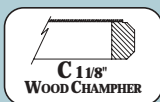
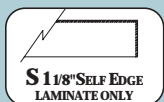

GROMMETS



ONE PER TOP INCLUDED FOR ADDITIONAL, ADD

SIZE	FACTORY INSTALLED	GROMMET COVER ONLY
2"	\$22	\$12
3"	\$22	\$14

SPECIFY LOCATION

OPEN HUTCH



TOPPER

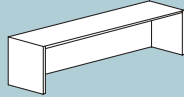

H	W	MEL INT/ LAM EXT Price	ALL LAMINATE Price
12	24	\$311	\$587
12	36	322	610
12	48	339	631
15	24	368	644
15	36	390	670
15	48	424	702

OPEN SHELF

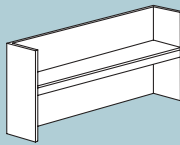

36	72	603	907
36	60	544	884
36	48	600	794
36	36	446	771
30	72	572	884
30	60	516	850
30	48	461	769
30	36	424	736

OPEN SHELF WITH TOP

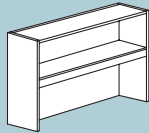

36	48	587	968
36	36	524	891
30	48	558	923
30	36	497	850

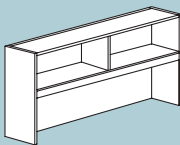

36	72	758	1,133
36	60	673	1,080
30	72	718	1,103
30	60	637	1,026

OPEN WITH ADJUSTABLE SHELF

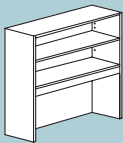

48	48	849	1,449
48	36	752	1,325
42	48	758	1,294
42	36	***667	1,183
36	48	684	1,126
36	36	597	1,018

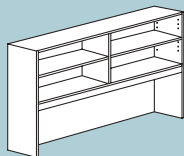

48	72	1,195	1,837
48	60	998	1,685
42	72	1,058	1,632
42	60	884	1,492
36	72	917	1,377
36	60	790	1,273

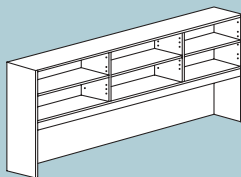

48	96	1,334	2,064
48	84	1,293	1,947
42	96	1,183	1,827
42	84	1,145	1,724
36	96	992	1,701
36	84	953	1,643
Add'l Shelves		\$30 ea	\$86 ea

HINGE DOOR/FLIPPER DOOR WORK SURFACE MOUNT

MELAMINE
INTERIOR LAMINATE
EXTERIOR TOP
ENDS, DOORS

ALL
LAMINATE

2 HINGE DOORS

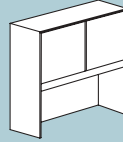

H	W	Shelf	Price	Price
48	42	1	\$1,106	\$1,725
48	36	1	998	1,590
42	42	1	980	1,528
42	36	1	884	1,408
36	42	0	912	1,349
36	36	0	822	822

3 HINGE DOORS

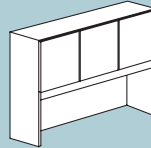

48	48	1	1,118	1,740
42	48	1	991	1,540
36	48	0	918	1,356

4 HINGE DOORS

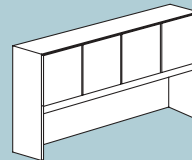

48	72	1	1,455	2,057
48	60	1	1,273	2,316
42	72	1	1,303	1,843
42	60	1	1,137	1,747
36	72	0	1,165	1,643
36	60	0	1,050	1,528

6 HINGE DOORS

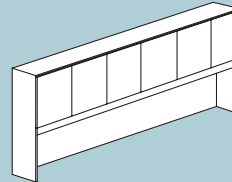

48	96	1	1,709	2,410
48	84	1	1,664	2,316
42	96	1	1,540	2,172
42	84	1	1,500	2,087
36	96	0	1,356	2,046
36	84	0	1,311	1,988

1 FLIPPER DOOR

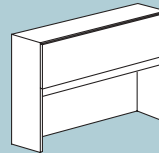

42	48		1,049	1,222
42	42		1,032	1,203
42	36		1,011	1,174
36	48		953	1,102
36	42		938	1,084
36	36		909	1,057

2 FLIPPER DOORS

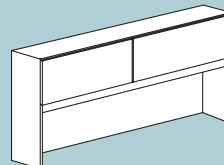

42	84		1,233	1,452
42	72		1,206	1,420
42	60		1,168	1,375
36	84		1,121	1,319
36	72		1,098	1,290
36	60		1,064	1,249

Custom Sizes Available. For assistance in design layout
Telephone: 410-233-2255 Fax: 410-233-8554

FORM/MAIL BIN HUTCH



STANDARD DEPTH 13"

INTERIOR OF BINS ARE MELAMINE

BIN HEIGHT CALCULATED ON 3 SHELVES PER SECTION

MELAMINE COLORS AVAILABLE - BLACK, WHITE, GREY, ALMOND

3 SECTIONS

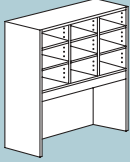

H	W	NO. OF SECTIONS	BIN W	BIN H	MEL INT/LAM EXT
42	36	3	11	6 1/4	\$704
42	42	3	13	6 1/4	725
36	36	3	11	4 1/4	584
36	42	3	13	4 1/4	626

4 SECTIONS

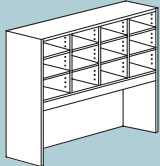

42	48	4	11	6 1/4	920
42	54	4	12 1/2	6 1/4	982
36	48	4	11	4 1/4	780
36	54	4	12 1/2	4 1/4	862

5 SECTIONS

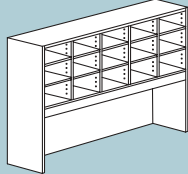

42	60	5	11	6 1/4	1,058
42	66	5	12 1/4	6 1/4	1,086
36	60	5	11	4 1/4	926
36	66	5	12 1/4	4 1/4	862

6 SECTIONS

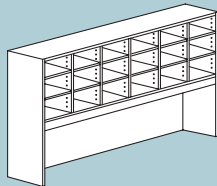

42	72	6	11	6 1/4	1,168
42	78	6	12	6 1/4	1,295
36	72	6	11	4 1/4	1,030
36	78	6	12	4 1/4	1,132

7 SECTIONS

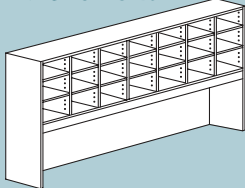

42	84	7	11	6 1/4	1,254
42	90	7	12	6 1/4	1,378
36	84	7	11	4 1/4	1,127
36	90	7	12	4 1/4	1,254

OPTIONAL: ADDITIONAL SHELVES \$20 EA

TASK LIGHT IN HUTCH \$200 EA

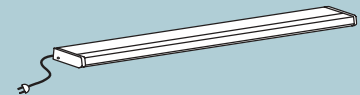

FABRIC TACK PANELS

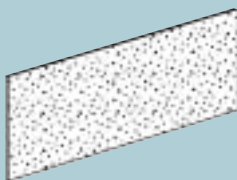

H
E
I
G
H
T

	L E N G T H							
	24	30	36	48	60	72	84	96
15	\$74	\$91	\$110	\$145	\$184	\$215	\$263	\$299
18	79	100	119	158	197	236	275	315
24	105	131	158	210	263	315	368	420
30	130	165	196	263	328	394	457	525
36	158	196	236	315	394	472	551	630
48	210	263	315	420	525	630	735	840
60	263	328	394	525	656	788	919	1,050

BLANK CORNER FILL

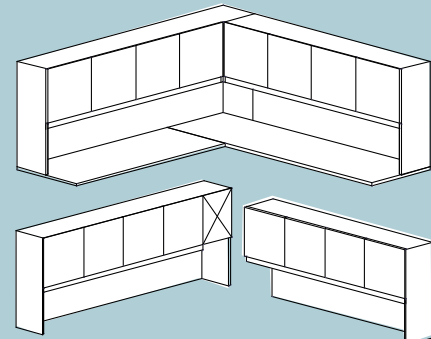

USE WITH ANY HUTCH UNITS;
PRICE CORRECT SIZE OF UNIT AND ADD: \$300

WALL HUNG STORAGE UNITS



OPEN SHELF

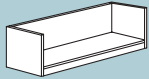

H	W	MEL INT/ LAM EXT Price	ALL LAMINATE Price
15	36	\$344	\$603
15	48	351	626
15	60	402	654

OPEN SHELF W/TOP

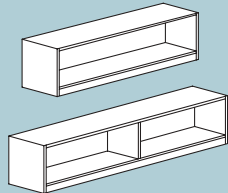

16	36	397	620
16	48	401	659

16	60	\$447	\$700
16	72	503	720
16	84	568	752
16	90	635	804

2 SHELF

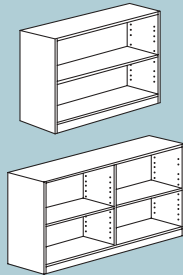

30	36	597	804
36	36	616	844
30	48	632	903
36	48	662	958

30	60	780	1,040
36	60	844	1,140
30	72	871	1,225
36	72	910	1,273
30	84	958	1,411
36	84	1,040	1,494

STANDARD DEPTH 13"
INTERIOR OF BIN SECTIONS MELAMINE
BIN HEIGHT CALCULATED ON 3 SHELVES PER SECTION

OPEN BINS

3 SECTIONS

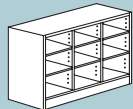

H	W	NO. OF SECTIONS	BIN W	BIN H	MEL INT/ LAM EXT
24	36	3	11	6	\$447
30	36	3	11	8	520
36	36	3	11	10	572

4 SECTIONS

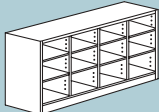

24	48	4	11	6	\$520
30	48	4	11	8	611
36	48	4	11	10	662

5 SECTIONS

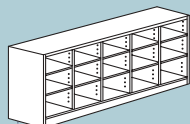

24	60	5	11	6	\$697
30	60	5	11	8	766
36	60	5	11	10	844

6 SECTIONS

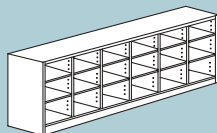

24	72	6	11	6	\$765
30	72	6	11	8	846
36	72	6	11	10	923

ADDITIONAL SHELVES \$20 EACH

STANDARD DEPTH 13"
INTERIOR OF BIN SECTIONS MELAMINE
BIN HEIGHT CALCULATED ON 3 SHELVES PER SECTION

WALL HUNG DOOR STORAGE

STANDARD DEPTH 13"

2 DOOR

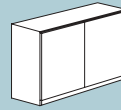

H	W	Shelves	MELAMINE Price	MEL INT/ LAM EXT Price
24	36	1	\$453	\$644
30	36	2	485	669
36	36	2	522	748
24	36	1	488	669
30	36	2	522	736
36	36	2	597	844
24	36	1	515	713
30	36	2	584	833
36	36	2	669	952

4 DOOR

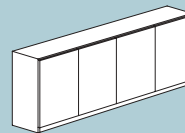

24	60	1	\$612	\$869
30	60	2	715	1,014
36	60	2	814	1,157
24	66	1	669	948
30	66	2	777	1,104
36	66	2	888	1,260
24	72	1	725	1,026
30	72	2	842	1,197
36	72	2	961	1,373

6 DOOR

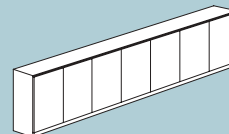

SHIPPED IN
2 SECTIONS

24	84	1	\$874	\$1,219
30	84	2	1,012	1,424
36	84	2	1,166	1,624
24	90	1	934	1,300
30	90	2	1,088	1,516
36	90	2	1,244	1,731
24	96	1	991	1,380
30	96	2	1,155	1,608
36	96	2	1,320	1,838

ADDITIONAL SHELVES \$40 EACH

FLIPPER DOOR UNITS

15" DEEP LAMINATE EXTERIOR

1 DOOR

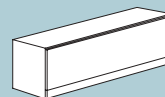

17 1/2	30	N/A	\$462
17 1/2	36	N/A	527
17 1/2	42	N/A	591
17 1/2	48	N/A	656
17 1/2	60	N/A	849
17 1/2	66	N/A	915
17 1/2	72	N/A	980
17 1/2	78	N/A	1,044
17 1/2	84	N/A	1,111
17 1/2	96	N/A	1,240

2 DOOR

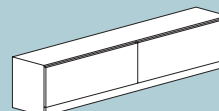



STANDARD DEPTH 13"

INTERIOR OF BINS ARE MELAMINE

BIN HEIGHT CALCULATED ON 6 SHELVES PER SECTION

MELAMINE COLORS AVAILABLE - BLACK, WHITE, GREY, ALMOND

3 SECTIONS

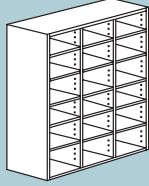

H	W	NO. OF SECTIONS	BIN W	BIN H	MEL INT/LAM EXT
42	36	3	11	6	\$692
42	42	3	13	6	771
36	36	3	11	5	649
36	42	3	13	5	725

4 SECTIONS

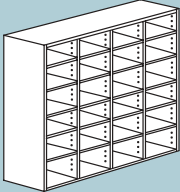

42	48	4	11	6	849
42	54	4	12 1/4	6	929
36	48	4	11	5	798
36	54	4	12 1/4	5	874

5 SECTIONS

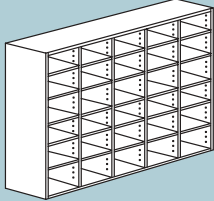

42	60	5	11	6	1,007
42	66	5	12 1/4	6	1,086
36	60	5	11	5	948
36	66	5	12 1/4	5	1,021

6 SECTIONS

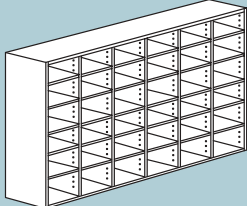

42	72	6	11	6	1,164
42	78	6	12	6	1,244
36	72	6	11	5	1,095
36	78	6	12	5	1,171

7 SECTIONS

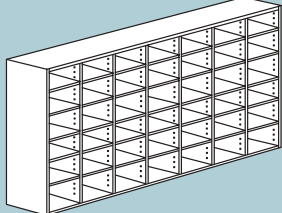

42	84	7	11	6	1,320
42	90	7	12	6	1,401
36	84	7	11	5	1,244
36	90	7	12	5	1,320

Optional: Additional Shelves \$20 EA

Custom Sizes Available. For assistance in design layout telephone: 410-233-2255 Fax: 410-233-8554

SHELVES



**3/4" thick
Melamine**

	12" WIDE
30	\$25
36	35
48	45
60	60
72	70
84	75
96	90



**1 1/8" thick
H.P. Laminate**

	12" WIDE
30	\$70
36	90
48	140
60	165
72	200
84	225
96	260

PEDESTALS/MOBILE PEDESTALS

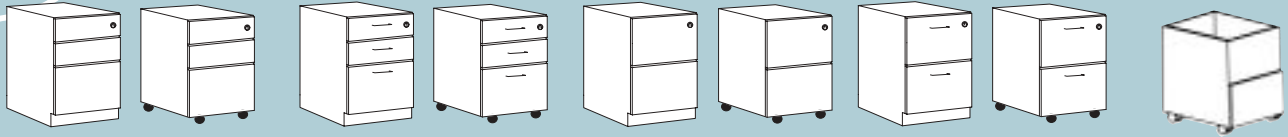

D	W	BOX BOX FILE		FILE FILE		BOX BOX FILE 'U' PULLS		FILE FILE 'U' PULLS		TUB FILE REG FILE
		w/casters		w/casters		w/casters		w/casters		casters
20 x 16		\$645	\$680	\$645	\$680	\$645	\$680	\$645	\$680	\$591
24 x 16		680	703	680	703	6801	703	680	703	611

(Lock Included)

All mobile pedestals include anti-tilt 5th wheel.

LATERAL FILES

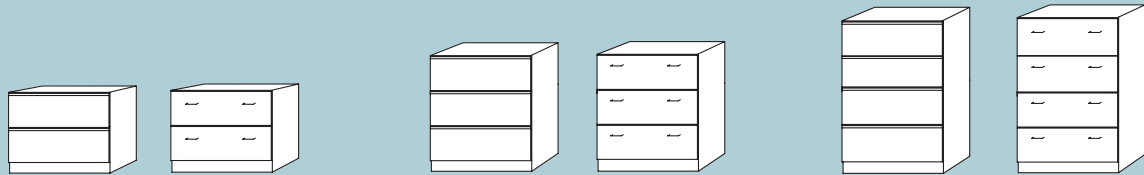

D	W	2 DRAWER	WITH 'U' PULLS	3 DRAWER	WITH 'U' PULLS	4 DRAWER	WITH 'U' PULLS
		HT 28"	HT 28"	HT 40"	HT 40"	HT 52"	HT 52"
18 x 30		\$857	\$857	N/A	N/A	N/A	N/A
20 x 30		866	866	1,155	1,155	1,505	1,505
18 x 36		905	905	N/A	N/A	N/A	N/A
20 x 36		951	951	1,221	1,221	1,551	1,551
For Lock add		86	86	115	115	144	144

LATERAL FILE TOPPERS



	30W	36W	60W	72W	90W	108W
20" DEEP	\$156	\$182	\$301	\$366	\$421	\$518
24" DEEP	177	191	311	373	432	559

DOOR STORAGE/COAT & SHELF STORAGE

MELAMINE INTERIOR/LAMINATE EXTERIOR

SPECIFICATIONS: MELAMINE COLORS ARE LIMITED TO: GREY, BLACK, WHITE & ALMOND

LAMINATE IS YOUR SELECTION OF ANY STANDARD HIGH PRESSURE LAMINATE

ALL SHELVES ARE ADJUSTABLE 32MM ON CENTER

LOCKS ON DOORS / ADD \$60

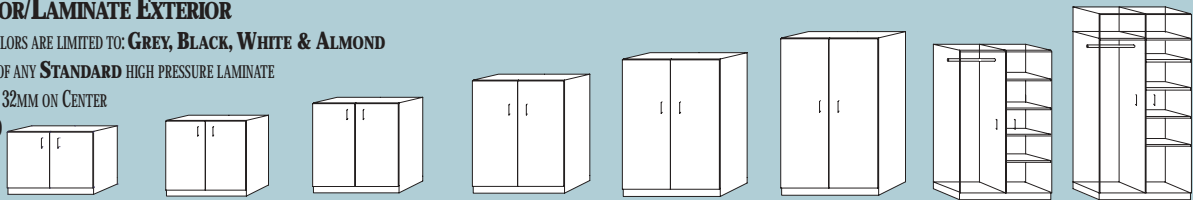

D	W	HT 29"	HT 36"	HT 48"	HT 60"	HT 72"	HT 84"	HT 72"	HT 84"
		20 x 24	\$742	\$750	\$850	\$880	\$1,035	\$1,180	LAM EXT/MEL INT ONLY
20 x 30	779	800	900	930	1,095	1,220			
20 x 36	873	880	954	993	1,148	1,317	\$1,587	\$1,908	

BOOKCASES

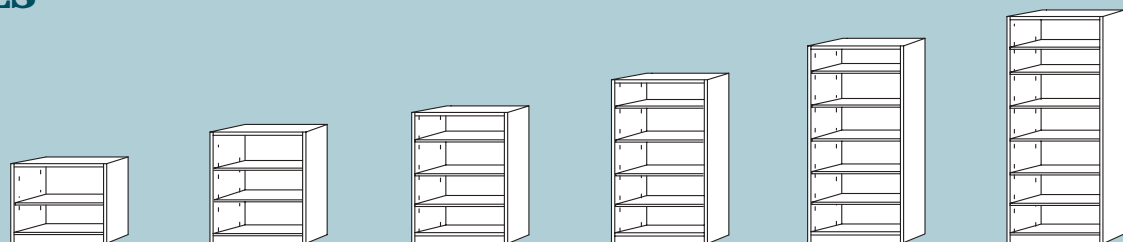

D	W	HT 29"		HT 36"		HT 48"		HT 60"		HT 72"		HT 84"	
		MEL INT/ LAM EXT	ALL LAM	MEL INT/ LAM EXT	ALL LAM	MEL INT/ LAM EXT	ALL LAM	MEL INT/ LAM EXT	ALL LAM	MEL INT/ LAM EXT	ALL LAM	MEL INT/ LAM EXT	ALL LAM
12 x 30		\$383	\$608	\$412	\$606	\$546	\$757	\$615	\$929	\$713	\$1,073	\$769	\$1,314
12 x 36		436	650	458	664	599	811	677	987	797	1,126	857	1,374

QUICK SHIP

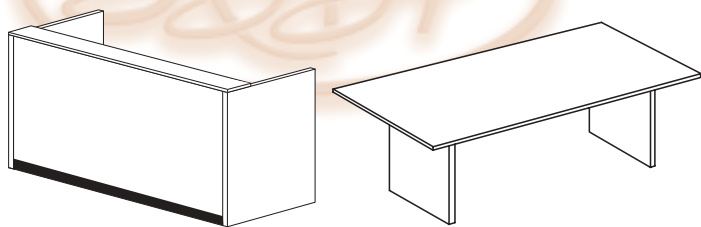

IN RESPONSE TO MANY REQUESTS WE HAVE ADDED TWO ITEMS TO A QUICK SHIP LIST

1. ITEMS ARE ONLY AVAILABLE IN SIZE SPECIFIED
2. LAMINATE SELECTION IS LIMITED TO STYLES AND COLORS WHICH ARE READILY ACCESSIBLE (NO SPECIAL ORDER LAMINATE) FROM MANUFACTURER'S INVENTORY.
3. ORDER WILL BE COMPLETE AND READY FOR SHIPMENT OR PICK-UP WITHIN 15 BUSINESS DAYS.

CONFERENCE TOPS

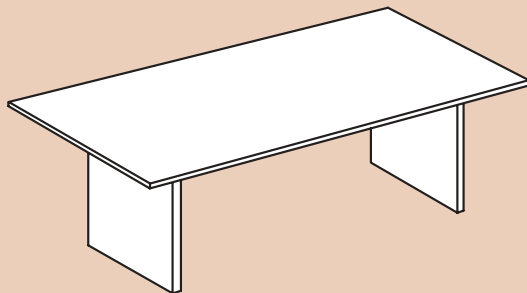

RECTANGULAR TABLE
1-1/8" SELF EDGE / 1 PC TOP / 2 SLAB LEGS

SIZE	PRICE
36 x 72	\$850
48 x 96	1,010
60 x 120	1,230

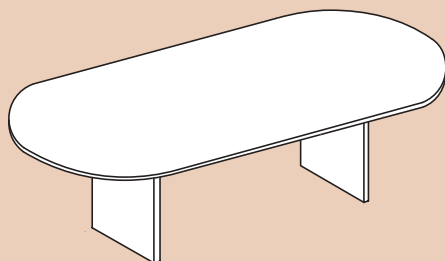

OVAL TABLE
1-1/8" SELF EDGE / 1 PC TOP / 2 SLAB LEGS

SIZE	PRICE
36 x 72	\$995
48 x 96	1,195
60 x 120	1,425



RECEPTION STATION

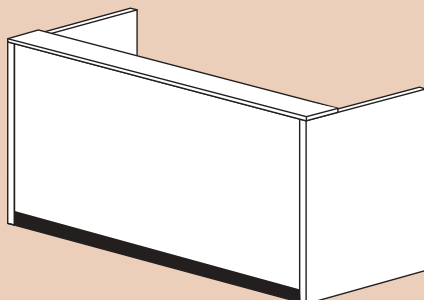

RECEPTION STATION
42" HIGH / RECESSED TOE / INCLUDES 12" TRANSTOP

	24 DEEP	30 DEEP
60W	\$1,355	\$1,415
72W	1,655	1,715
84W	1,770	1,845
96W	1,875	1,945

DESKS

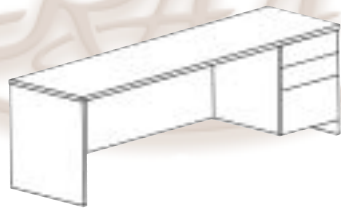

For Additional Storage
Think Vertical with Hutch Storage

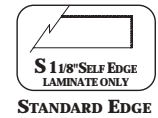

CREATE YOUR OWN CUSTOM DESK CONFIGURATION

- 1) SELECT BASIC STYLE OF DESK & EDGE TREATMENT...
- 2) CHOOSE BRIDGE AND/OR RETURN WITH ACCESSORIES AS DESIRED...
- 3) FOR ADDITIONAL STORAGE THINK UP WITH HUTCHES...

Quotes are given in Standard HPL which includes solids and regular woodgrains in a matte finish with melamine interiors...

Melamine selection:

White Black Grey Almond

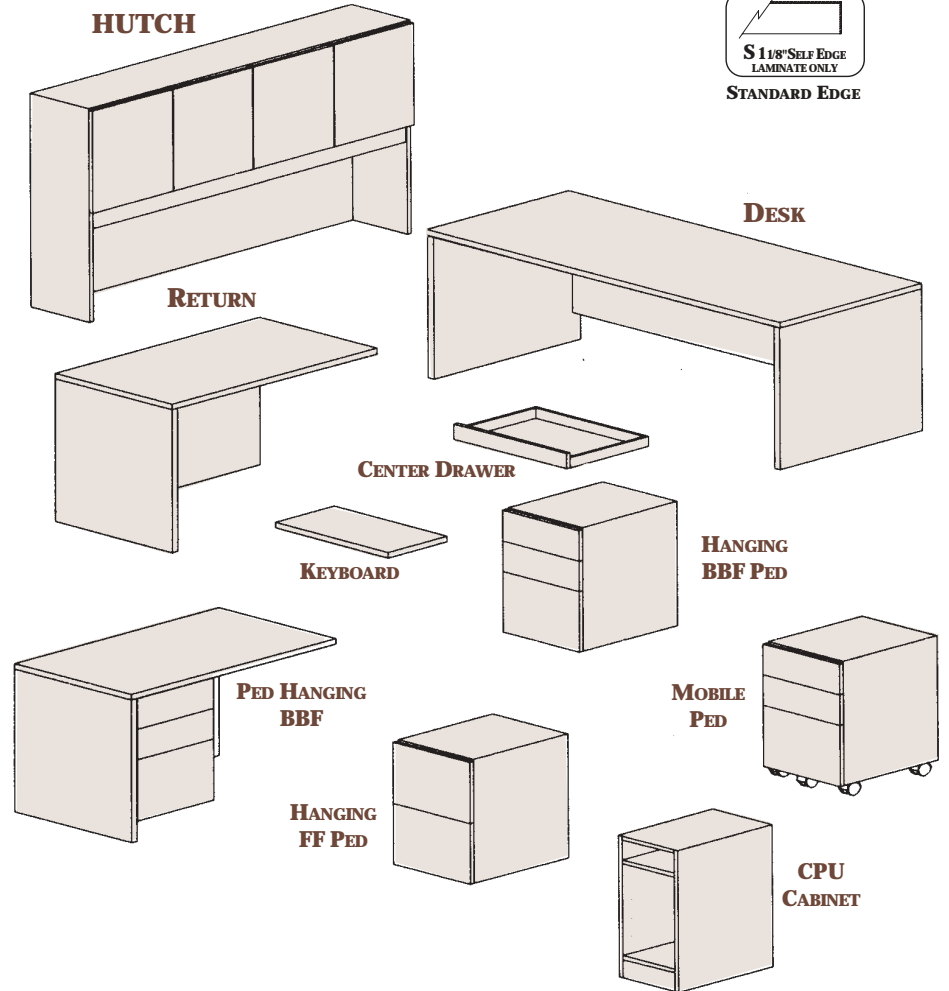

AVAILABLE EDGE TREATMENTS

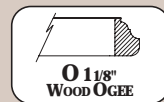
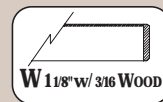
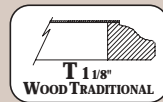
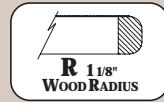
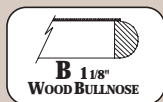
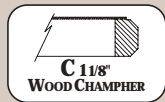

STORAGE OPTIONS

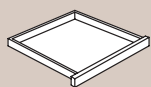

PENCIL DRAWER
\$160

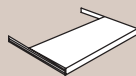

KEYBOARD
\$160



FREESTANDING DRAWER PEDESTALS
\$550



MOUNTED DRAWER PEDESTALS
\$498

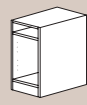
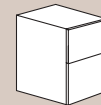
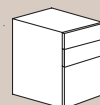

CPU CABINET
12" W
\$274

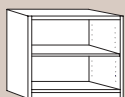

PRINTER CABINET
24" W 30" W
\$561 \$633

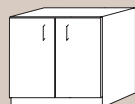

PRINTER CABINET
24" W 30" W
\$676 \$751

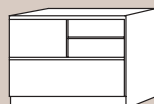

COMBO FILE
32" W
\$900

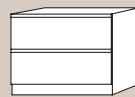

LATERAL FILE
30" W 36" W
\$782 \$834

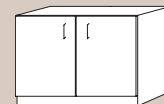

DOOR STORAGE CABINET
24" W 30" W 36" W
\$546 \$604 \$676

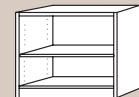

OPEN SHELF STORAGE
24" W 30" W 36" W
\$431 \$489 \$518

SINGLE PEDESTAL DESKS

DOUBLE PEDESTAL DESKS

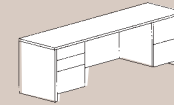
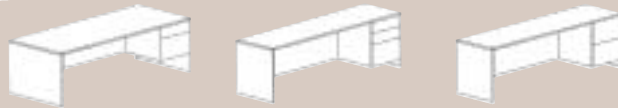

D	W	Shell Box File	Shell Box Box File	Shell File File
30	72	\$1,149	\$1,206	\$1,206
30	66	1,127	1,185	1,185
30	60	1,075	1,133	1,133
24	72	1,060	1,118	1,118
24	66	1,027	1,084	1,084
24	60	975	1,032	1,033

D	W	Shell Box Box File	Shell File File
30	72	\$1,647	
30	66	1,625	
30	60	1,573	
24	72	1,558	
24	66	1,525	
24	60	1,473	

(ALL DESK & RETURNS INCLUDE 1 GROMMET PER TOP.) Please specify left or right

RETURNS

BRIDGE

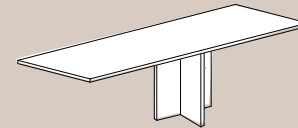
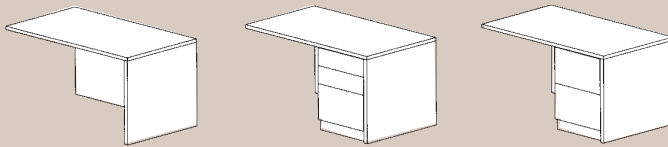

INCLUDES APPROPRIATE NUMBER OF SUPPORT LEGS

D	W	Top/Mod/Panel Leg	Top/BBF Ped	Top F/F Ped
20 x 42		\$601	\$848	\$848
20 x 48		615	866	866
24 x 42		630	896	896
24 x 48		645	888	888

W	18'D	20'D	24'D
42	\$322	\$354	\$400
48	339	371	417
54	388	426	472
60	403	443	489

(ALL DESK & RETURNS INCLUDE 1 GROMMET PER TOP.) Please specify left or right

SHELL DESK

MOBILE DESK

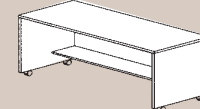
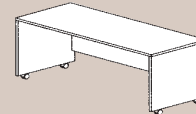
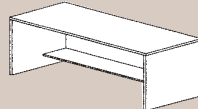
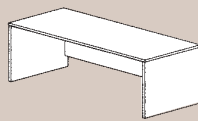

D	W	Table Desk	Table Desk with Shelf
24 x 48		\$699	\$768
24 x 60		757	826
24 x 66		818	887
24 x 72		848	913
30 x 48		808	877
30 x 60		876	945
30 x 66		952	1,021
30 x 72		1,002	1,070
36 x 72		1,107	1,173

D	W	Table on Casters	Table on Casters with Shelf
18 x 30		\$647	\$705
18 x 36		677	735
18 x 48		730	788
24 x 30		677	735
24 x 36		689	746
24 x 48		746	804

(ALL DESK & RETURNS INCLUDE 1 GROMMET PER TOP.)

KEYS

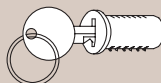

LOCK CHANGE TOOL
\$30 EA
REQUIRED TO INSTALL &
REMOVE LOCK CYLINDERS



MASTER KEY
\$35 EA

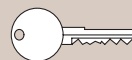

ADDITIONAL KEY
\$15 EA

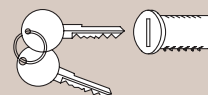

REPLACEMENT LOCK
\$38 EA

PENINSULA DESKS



RADIUS END TOP WITH 3" BLACK LEG

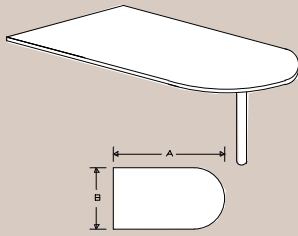

A	B	COST
48	30	\$407
60	30	476
72	30	545

RADIUS END TOP WITH 3" BLACK LEG AND 'T' SUPPORT LEG

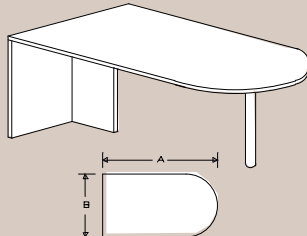

A	B	COST
48	30	\$580
60	30	650
72	30	717

RADIUS END TOP WITH PEDESTAL AND 3" BLACK SUPPORT LEG

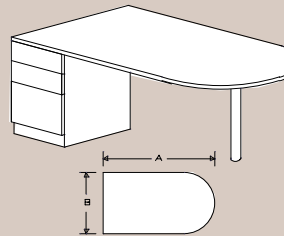

A	B	COST
48	30	\$1,067
60	30	1,136
72	30	1,205

RADIUS END TOP WITH MOD PANEL SUPPORT LEG AND 3" BLACK POLE LEG

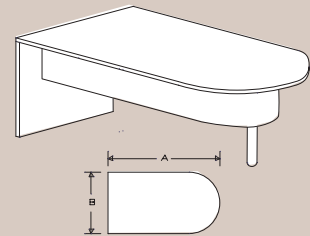

A	B	COST
48	30	\$1,018
60	30	1,087
72	30	1,158

'P' TOP WITH 6" BLACK LEG (PLEASE SPECIFY LEFT OR RIGHT)

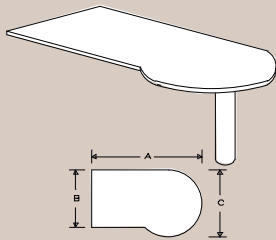

A	B	C	COST
60	30	42	\$770
72	30	42	892

'P' TOP WITH 6" BLACK LEG AND 'T' SUPPORT LEG

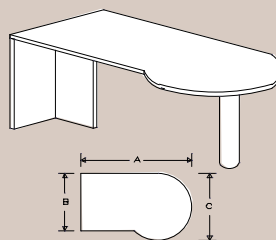

A	B	C	COST
60	30	42	\$966
72	30	42	1,065

'P' TOP WITH 6" BLACK LEG AND PEDESTAL

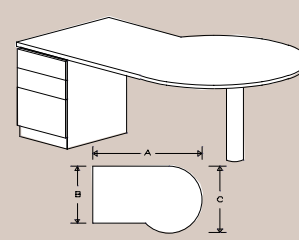

A	B	C	COST
60	30	42	\$1,454
72	30	42	1,552

ROUND END TOP WITH 6" BLACK LEG

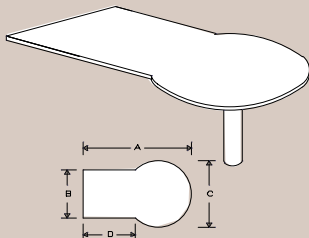

A	B	C	D	COST
72	30	42	36	\$892
72	36	42	40	897
84	36	42	52	994
96	36	42	64	1,088
40	30	36	32	817
72	30	36	44	856
84	30	36	56	945
96	30	36	68	1,044

ROUND END TOP WITH 6" BLACK LEG AND 'T' SUPPORT LEG

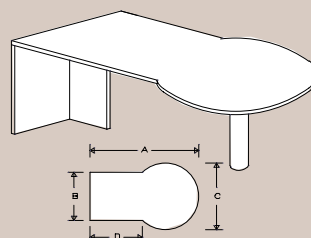

A	B	C	D	COST
72	30	42	36	\$1,070
72	36	42	40	1,070
84	36	42	52	1,166
96	36	42	64	1,260
40	30	36	32	989
72	30	36	44	1,028
84	30	36	56	1,118
96	30	36	68	1,217

ROUND END TOP WITH 6" BLACK LEG AND PEDESTAL

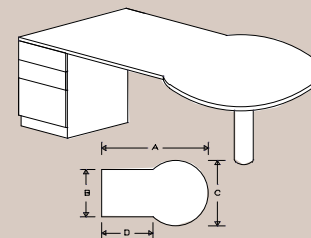

A	B	C	D	COST
72	30	42	36	\$1,557
72	36	42	40	1,557
84	36	42	52	1,651
96	36	42	64	1,748
40	30	36	32	1,477
72	30	36	44	1,513
84	30	36	56	1,605
96	30	36	68	1,704

CREDENZA

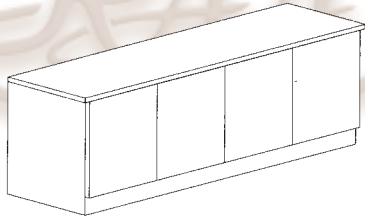

DESIGN YOUR OWN CREDENZA THE RAA WAY...

1. SELECT CREDENZA SHELL, SIZE, STYLE & EDGE TREATMENT
2. SELECT ANY COMBINATION OF BASE UNITS FOR UNDER SHELL
3. ADD ACCESSORIES AS NEEDED

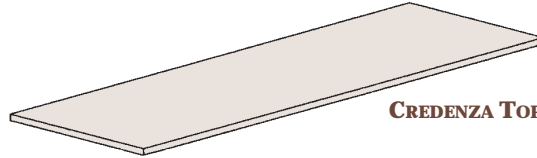

CREDENZA TOP



S 1 1/8" SELF EDGE LAMINATE ONLY
STANDARD EDGE

Quotes are given in Standard HPL which includes solids and regular woodgrains in a matte finish with melamine interiors...

Melamine selection:

White Black Grey Almond

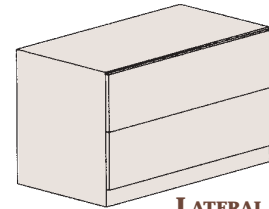
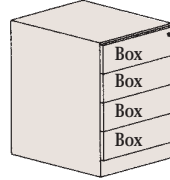
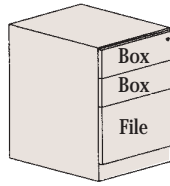
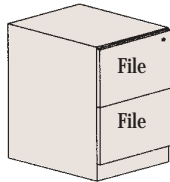

LATERAL FILE

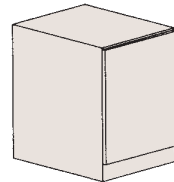

DOOR STORAGE

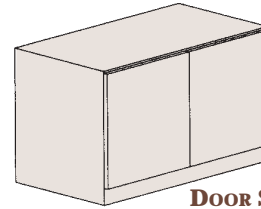

DOOR STORAGE

TOP



Depth	Width	TOP
20	x 60	\$301
20	x 66	329
20	x 72	366

ACCESSORIES

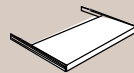

PENCIL DRAWER
INSIDE DOOR/DOOR UNIT
\$160

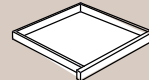

KEYBOARD
INSIDE DOOR/DOOR UNIT
\$160

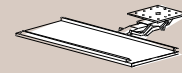

ARTICULATING KEYBOARD
PULL OUT SHELF
INSIDE DOOR/DOOR UNIT
\$350

STORAGE OPTIONS

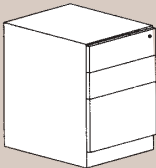

BOX BOX
FILE
\$550

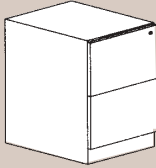

FILE
FILE
\$550

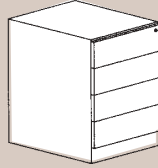

BOX BOX
BOX BOX
\$572

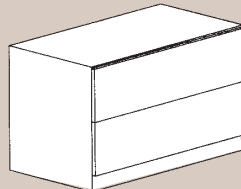

LATERAL FILE
30W \$782
33W 815
36W 834

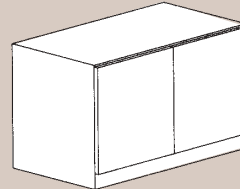

DOOR STORAGE
30W \$604
33W 667
36W 676

(1 adjustable shelf included)

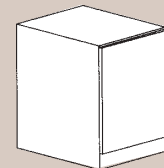

DOOR STORAGE
16W \$604

(1 adjustable shelf included)

(exact size of door storage & lateral files may vary to accommodate other elements.)

AVAILABLE EDGE TREATMENTS

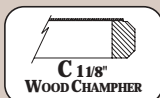

C 1 1/8"
WOOD CHAMFER

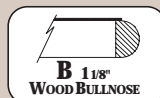

B 1 1/8"
WOOD BULLNOSE

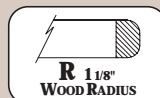

R 1 1/8"
WOOD RADIUS



O 1 1/8"
WOOD OGEE

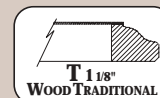

T 1 1/8"
WOOD TRADITIONAL

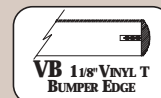

VB 1 1/8" VINYL T
BUMPER EDGE



HVB 1 1/2" HEAVY
BUMPER EDGE

LABS & STORAGE AREAS

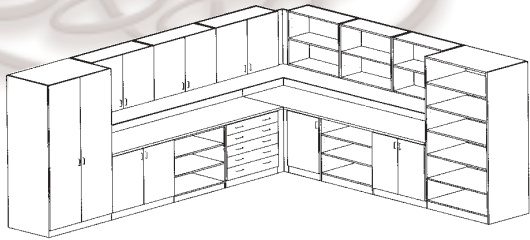

DESIGN YOUR OWN STORAGE AREA

1. MEASURE AREA TO BE DESIGNED
2. DECIDE WORKTOP LOCATION
3. LAYOUT BASE CABINETS USING ANY COMBINATION OF THE STANDARD SIZES OFFERED
4. BE SURE TO INCLUDE SPLASH, FILLERS, AND END PANELS AS NEEDED

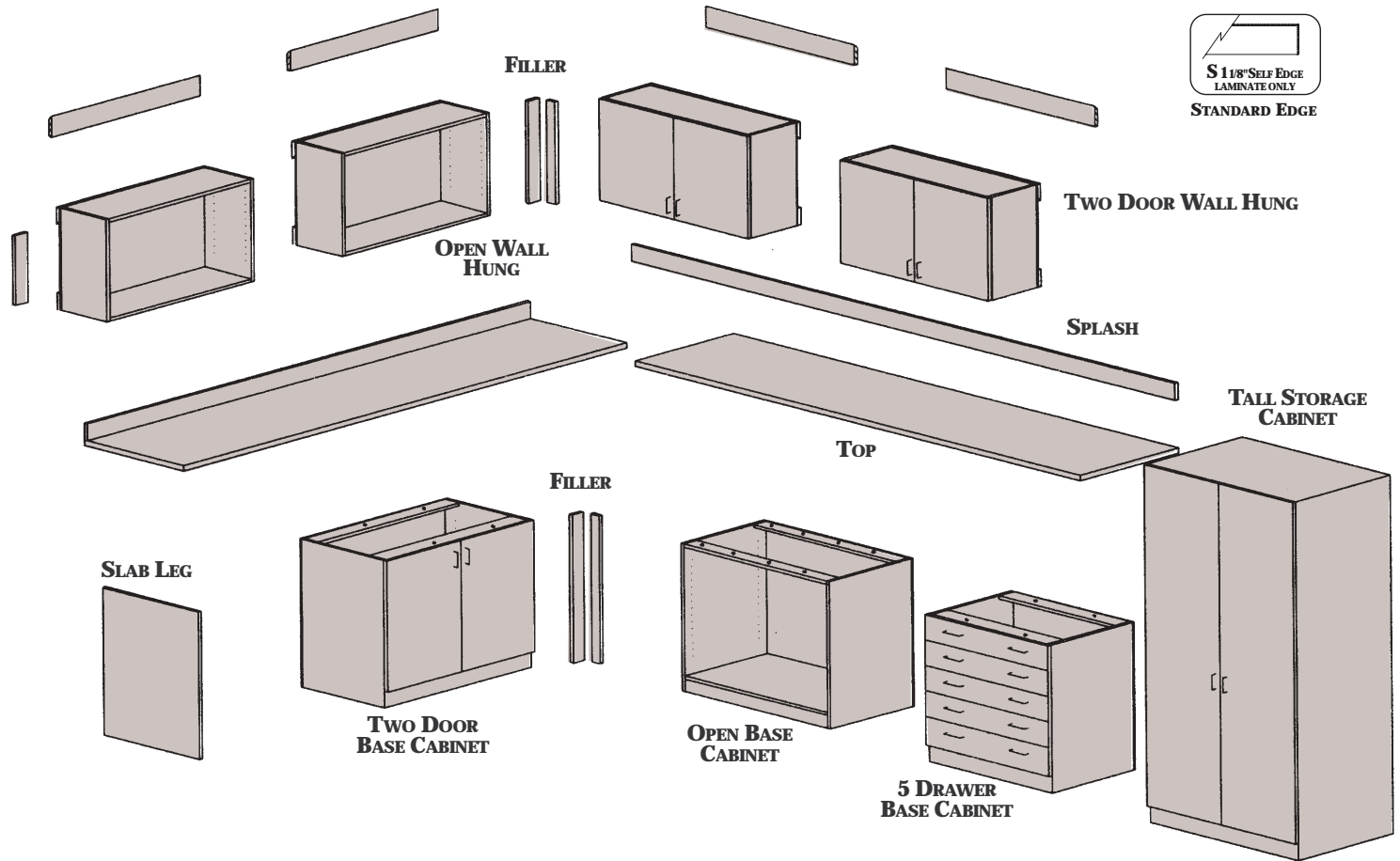

WALL CABINETS

OPEN SHELF

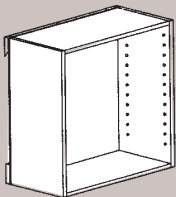

W	H	PRICE
16	30	\$280
18	30	315
24	30	405
30	30	505
16	36	310
18	36	345
24	36	460
36	36	565

ONE DOOR

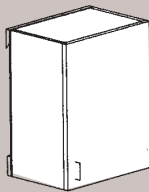

W	H	PRICE
16	30	\$340
18	30	375
24	30	495
16	36	360
18	36	405
24	36	540

TWO DOOR

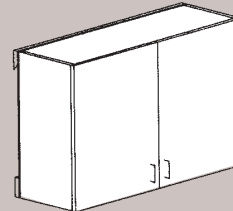

W	H	PRICE
30	30	610
36	30	735
30	36	675
36	36	815

- 12" Depth with unfinished tops and sides.
- 30" high units will have 1 adjustable shelf and 36" high units will have 2 adjustable shelves.
- All one door cabinets hinged right unless specified.
- White Melamine interior finish is standard.
- All cabinets come standard with 11-1/4" clear depth.
- To have exposed side finished, please specify side (right or left) and add \$95 for each.

BASE CABINETS

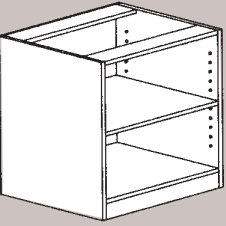

OPEN SHELF

W	H	PRICE
24	30	\$495
30	30	625
36	30	750
24	36	540
30	36	675
36	36	810

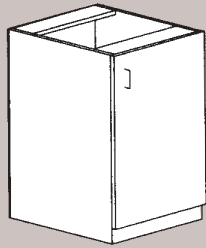

ONE DOOR

W	H	PRICE
16	30	\$365
18	30	405
24	30	540
16	36	390
18	36	435
24	36	580

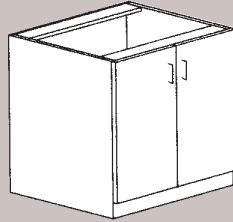

TWO DOOR

W	H	PRICE
30	30	\$675
36	30	810
30	36	725
36	36	870

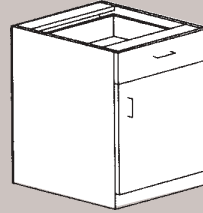

**DRAWER OVER DOOR
ONE DOOR**

W	H	PRICE
16	30	\$325
18	30	495
24	30	750
16	36	530
18	36	580
24	36	785

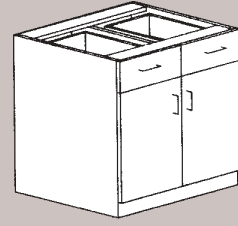

**DRAWER OVER DOOR
TWO DOOR**

W	H	PRICE
30	30	\$935
36	30	1,120
30	36	990
36	36	1,190

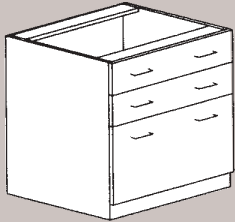

**TWO 6" DRAWERS
ONE 12" DRAWER**

W	H	PRICE
16	30	\$665
18	30	745
24	30	995
30	30	1,250
36	30	1,495

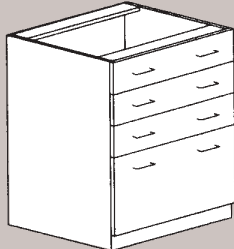

**THREE 6" DRAWERS
ONE 12" DRAWER**

W	H	PRICE
16	36	\$780
18	36	870
24	36	1,160
30	36	1,450
36	36	1,740

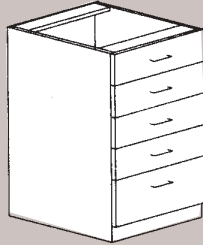

FIVE 6" DRAWERS

W	H	PRICE
16	30	\$870
18	30	965
24	30	1,250
30	30	1,540
36	30	1,830

Base Cabinets

- 20-3/4" Depth (2 Doors) with Unfinished tops, sides, and back.
- 30" high units will have 1 adjustable shelf.
- 36" high units will have 2 adjustable shelves.
- All drawers are white Melamine with pulls.
- Cabinet interiors can be black, white, gray or almond Melamine.
- To have exposed side finished, please specify side (right or left) and add \$130 for each.
- All one door cabinets hinged right unless specified.

SINK CABINETS

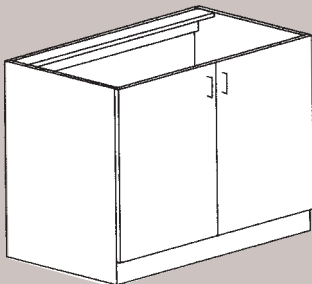

W	H	PRICE
24	36	\$599
30	36	723
36	36	872

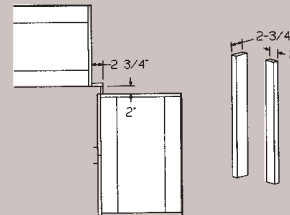
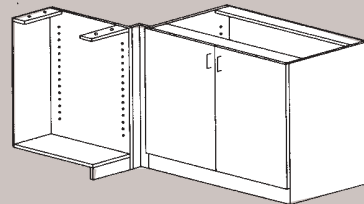
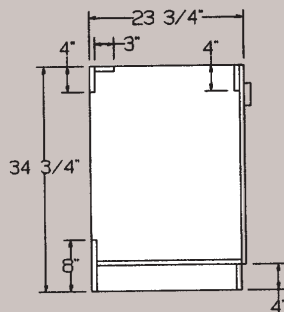

BACK SPLASH — COUNTER TOPS — SLAB LEGS — FILLER KIT

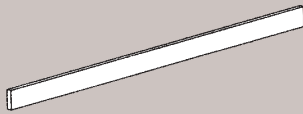

**4" HEIGHT
\$10 PER LINEAR FOOT**

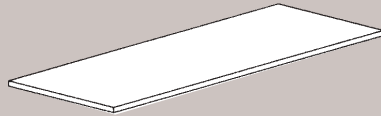

**1-1/8" SELF EDGE
\$99 PER LINEAR FOOT**

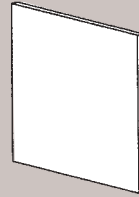

CABINET HGT.	PRICE
30	\$75
36	92



2 PC. KIT

BASE	
CABINET HGT.	PRICE
30	\$65
36	80
WALL	
CABINET HGT.	PRICE
24	\$65
30	80
36	98

TALL CABINETS

Cabinets are 84" high with unfinished tops, sides & back, with one stationary shelf & 4 adjustable shelves

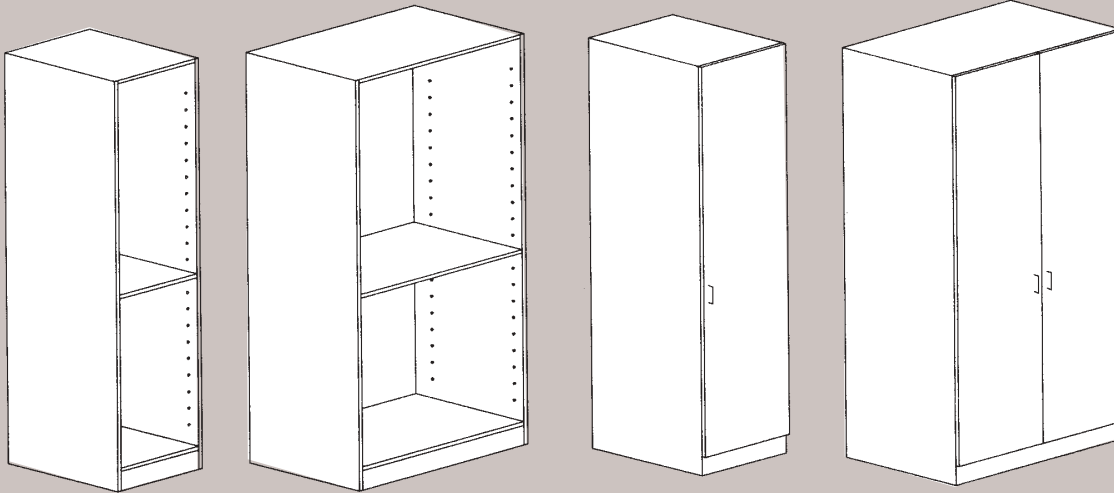

OPEN FRONT

W	H	PRICE
16	84	\$665
18	84	745
24	84	995
30	84	1,235
36	84	1,480

ONE DOOR

W	H	PRICE
16	84	\$1,520
18	84	1,740
24	84	2,315

TWO DOOR

W	H	PRICE
30	84	\$2,335
36	84	2,795

NOTE: All one door cabinets hinged right unless left is specified. Lock on door add \$100.00. To have finished sides on a cabinet, specify right, left or both & add \$180.00 to list price for each side finished.

SAMPLE SET-UP

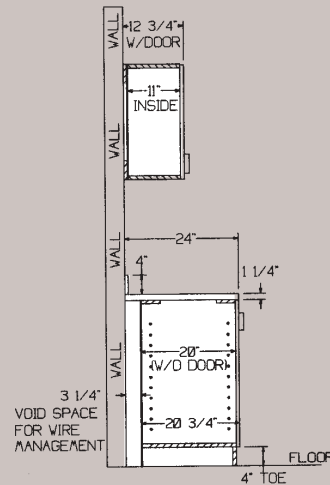
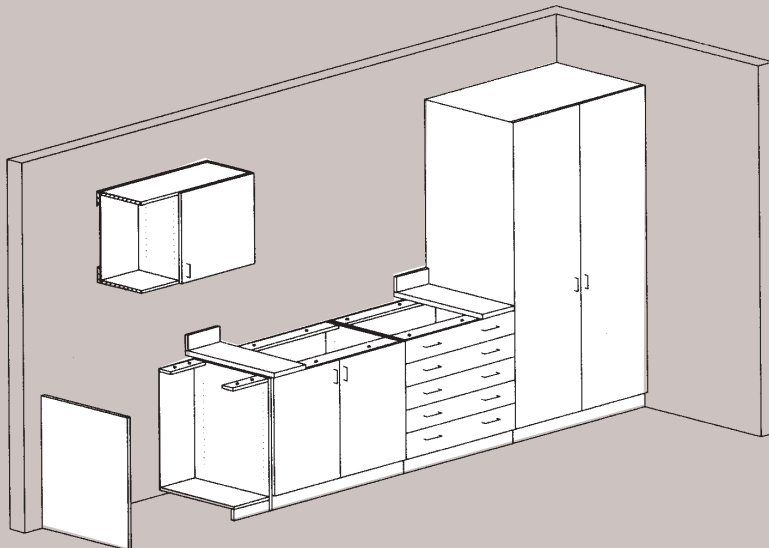

Our mission is to provide the best
quality custom office furniture for
our dealers at the most competitive
prices available in a timely manner.

Robert M. Anderson

Bob Anderson



R. A. Anderson
wood products, inc.

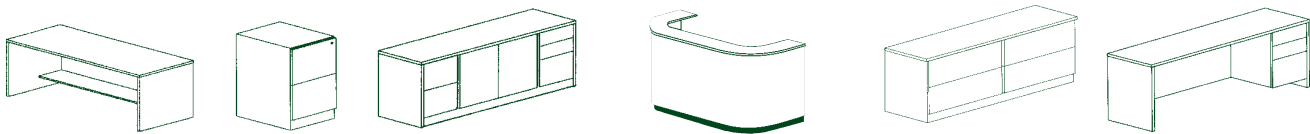

252 N. Franklinton Road • Baltimore, MD 21223 • 410-233-2255 • Fax: 410-233-8554
www.andersonwoodproducts.com • raa@msn.com